

# ACTION

# RESPONSE

Find the areas of the following rectangles, you must show your working:

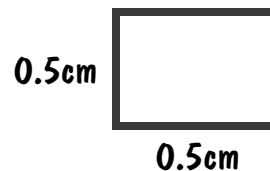
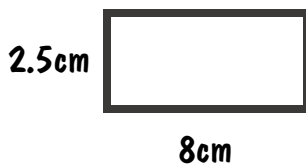
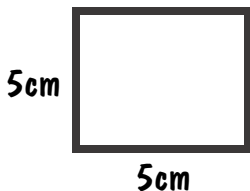
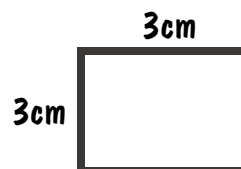
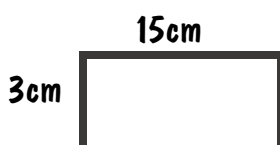
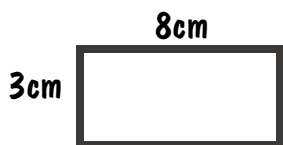

Fluency



Reasoning



Find the missing lengths in the rectangles below, the area is given inside.

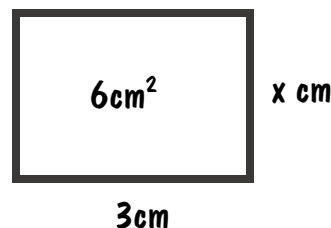
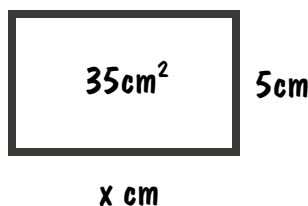
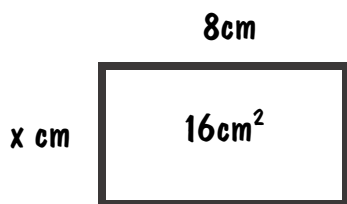

Problem Solving



Find the missing lengths and areas for the floor plans below:

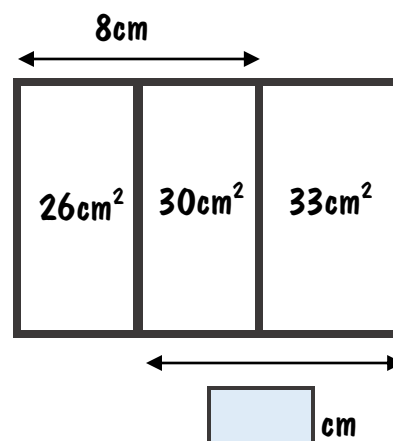
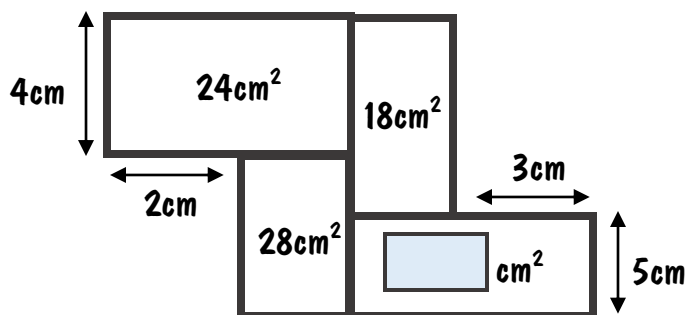

# ACTION

# RESPONSE

Find the areas of the following rectangles, you must show your working:

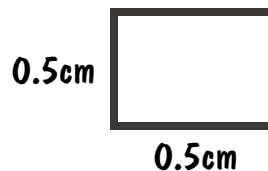
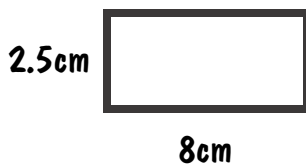
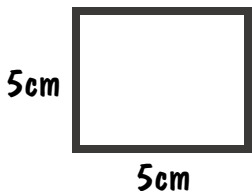
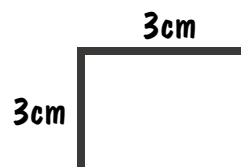
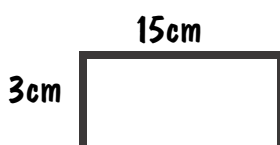
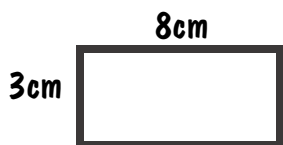

Fluency



Reasoning



Find the missing lengths in the rectangles below, the area is given inside.

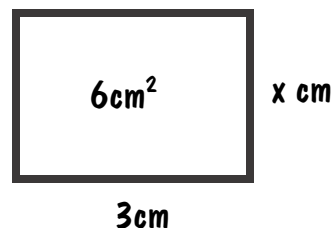
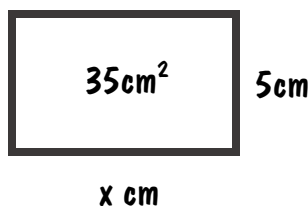
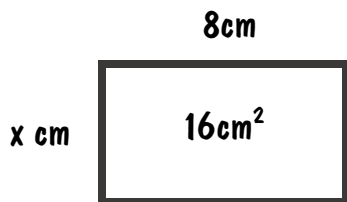

Problem Solving



Find the missing lengths and areas for the floor plans below:

